

ohne / without

Mutter / nut

max. Einschraubtiefe 5.0 mm  
thread depth max. 5.0 mm

Bolzen / bolt

max. Einschraubtiefe 5.5 mm  
thread depth max. 5.5 mm

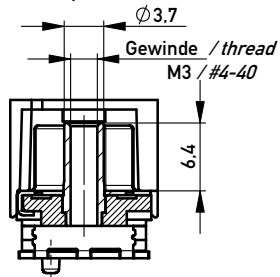
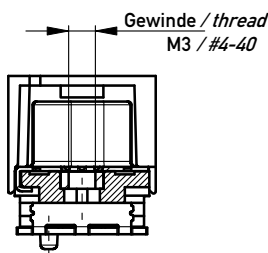
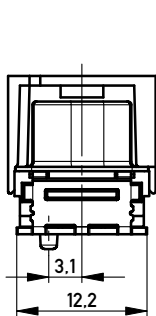

Beschriftung nach Bedruckungsvorschrift 174538  
Part marking according to specification 174538

194250	174385	X			
194251	204263			#4-40	
194252	164009			M3	
194253	164005		#4-40		
194254	164001		M3		
Ident-Nr. part-no. tape & reel	Ident-Nr. part-no. tray	ohne without	Mutter thread	Bolzen bolt	Bemerkung remark

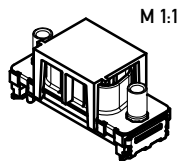

Anschlussbereich verzinkt  
terminal area tin plating

Koplanarität der Anschlüsse ≤ 0.1 mm  
coplanarity area of termination ≤ 0.1 mm

Anforderungsstufe: 2  
class: 2

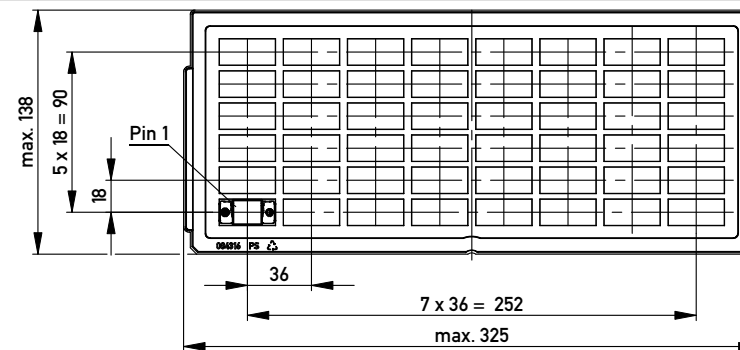

Verpackt in Tray  
Verpackungseinheit 48 St.  
tray packaging  
packaging unit 48 pcs

Sonstige Angaben siehe Zeichnung 204628 / Additional indications according to drawing 204628

Verpackt in Gurtverpackung - Tape on Reel Packaging  
Verpackungseinheit: 120 Stück - Packaging unit: 120 pcs

Abspulrichtung - Reel off Direction

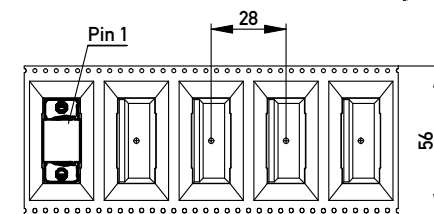
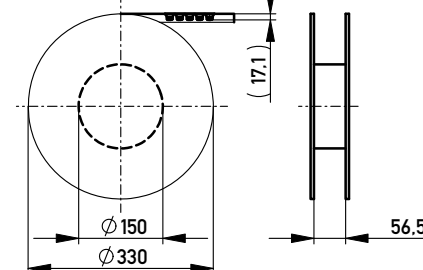

Sonstige Angaben siehe Zeichnung 204654 / Additional indications according to drawing 204654

Layoutvorschlag:  
recommended layout:

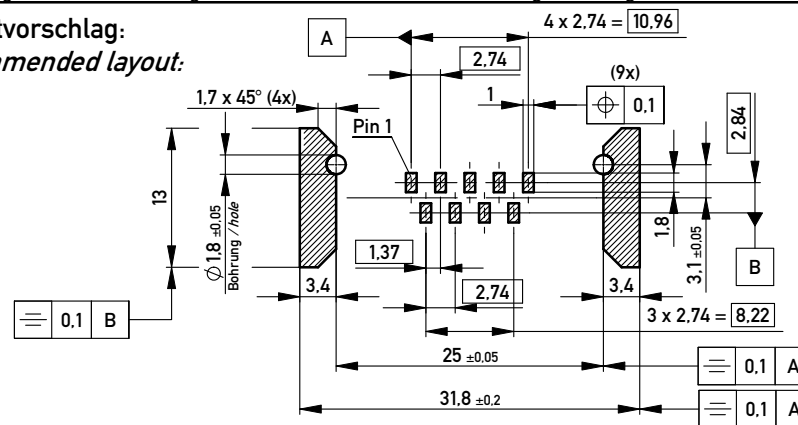

Fehlende Masse und Angaben siehe DIN 41652 / Missing information and dimensions according to DIN 41652

Sonstige Angaben siehe Fertigungsunterlagen / Additional indications please see the production documentation

Information:  All rights reserved. Only for Information. To ensure that this is the latest version of this drawing, please contact one of the ERNI companies before using.	Tolerances All Dimensions in mm	Scale 2:1	Designation <b>TMC-P 09-SMD-6.3-BA8</b> <i>TMC-P 09-SMD-6.3-type 8</i>
		144889	
f	21.04.2010	www.ERNI.com	i
Index	Date	ERNI	A3
Class		TMCP	

Copyright by ERNI GmbH  
Proprietary notice pursuant to ISO 16106 to be observed.